



Cube 30 ATV

Ventilator

User Manual

TABLE OF CONTENTS

1. INTRODUCTION	1
1.1 Intended use	1
1.2 Contraindication	1
1.3 Side effects	2
2. OVERVIEW OF THE DEVICE	3
2.1 Accessories	5
2.2 Explanation of symbols	8
3. PUTTING THE DEVICE INTO SERVICE	10
3.1 Setting up the device	10
3.2 Connecting the device	10
3.3 Fitting the respiratory mask	14
3.4 Connecting bacterial filter	15
4. USING THE DEVICE DAILY	16
4.1 Starting therapy	16
4.2 Setting the respiratory humidifier	16
4.3 Switching therapy sets	17
4.4 Handling alarms	17
4.5 Stopping therapy	20
4.6 Switching off the device	20
4.7 Travelling with device	20
5. FUNCTIONAL DESCRIPTION	22
5.1 General function of the device	22
5.2 Therapy modes	22
5.3 Additional therapy functions	24
5.4 Alarms	24
6. SETTING THE DEVICE	26
6.1 Control panel	26
6.2 Standby screen	27
6.3 Menu	30
6.4 Viewing the data logs	33
6.5 Data management	34
6.6 Function test	35

6.7	Testing the alarms	35
7.	OPERATING MALFUNCTIONS	38
7.1	Alarms	38
7.2	Handling errors	43
8.	CLEANING AND MAINTAINING THE DEVICE	47
8.1	Intervals	47
8.2	Cleaning	48
8.3	Maintenance	51
8.4	Disinfection	52
8.5	Disposing of	52
9.	SCOPE OF DELIVERY	54
9.1	Standard scope of delivery Cube 30 ATV	54
9.2	Accessories/spare parts	54
10.	TECHNICAL DATA	55
10.1	Technical data	55
10.2	Display values therapy status range	58
10.3	Setting ranges and accuracy of the therapy settings	59
10.4	Setting ranges and accuracy of the alarm parameters	61
10.5	Pneumatic circuit diagram	61
10.6	Protective Distance	62
11.	SAFETY INFORMATION/WARNINGS	63
11.1	Operating the device	63
11.2	Transport/maintenance	64
12.	INDEX	66

1. INTRODUCTION

Please read the complete user manual carefully before using the device.

This manual is aimed at users without clinical background. The manual is shortened compared to the clinical manual.

***Note** If questions on turning on, operating or maintaining the device remain, please contact your service provider.*

1.1 Intended use

This **Cube 30 ATV** is a device for non-invasive, non-life supporting respiration of spontaneously breathing patients who have a body weight of at least 13 kg and suffer from respiratory insufficiency.

These clinical pictures include:

- Chronic obstructive pulmonary disorder (COPD)
- Neurological, muscular and neuromuscular complaints, such as paresis of the diaphragm
- Restrictive ventilation disorders, e.g. scoliosis, thorax deformities
- Central respiratory regulatory disorders
- Obstructive sleep apnoea (OSA).

The device is suitable for use at home and in clinics (hospitals, sleep laboratories etc.).

It is possible to reuse the device for another patient. In this case the bacterial filter is required (see Page 15). You must follow the hygiene requirements of your physician and medical care provider.

1.2 Contraindication

The **Cube 30 ATV** is **not a life-supporting system** and may therefore not be used by patients that are only able to tolerate short interruptions in ventilation.

The use of the device could also be contraindicated among patients who suffer

from the following conditions:

- Pneumothorax or pneumomediastinum
- Risk of aspirating stomach contents
- Hypotension, particularly combined with intravascular volume depletion
- Fluid discharge, short-term cranial operation or trauma
- Acute sinus or middle-ear inflammation
- Dehydration
- Severe bullous pulmonary inflammation.

1.3 Side effects

Please contact your doctor immediately if you experienced severe headache, unusual chest pain or shortness of breath.

The following side effects can arise with non-invasive ventilation with this device:

- Irritation of the eye/conjunctiva inflammation
- Ear and nasal cavity symptoms
- Nose bleeds
- Skin irritation or damage
- Dryness of the mouth, throat or nose
- Bloating stomach or feeling of fullness.

2. OVERVIEW OF THE DEVICE

You will find the scope of supply included as standard in section 9.1 on Page 54.

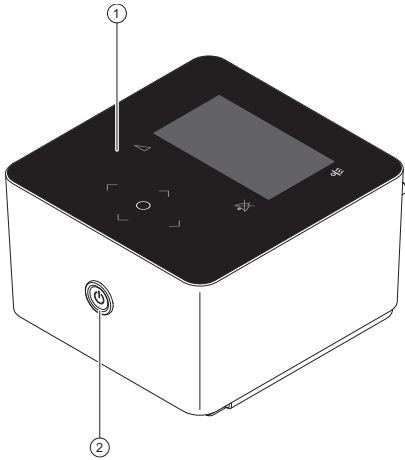

1. Control panel with display
2. Start/stop button

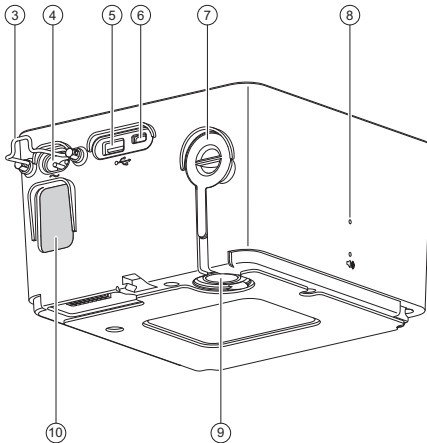

3. Safety clip (mains cable)
4. Mains socket
5. USB A connection
6. Micro USB connection
7. Air outlet (if used without respiratory humidifier) and silicone cover for air outlet
8. Loudspeaker
9. Air outlet (if used with respiratory humidifier)
10. Air inlet and fine or coarse filter

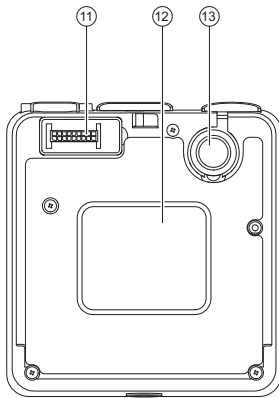

- 11. Connection socket for respiratory humidifier
- 12. Type plate
- 13. Air outlet (if used with respiratory humidifier)

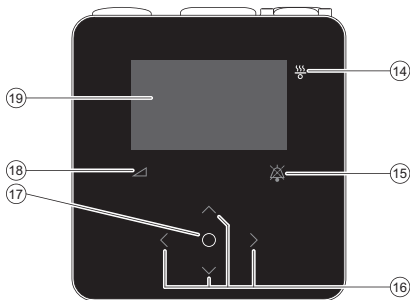

- 14. LED for respiratory humidifier
- 15. Audio-pause key
- 16. Navigation buttons
- 17. OK key
- 18. Ramp key
- 19. Display

2.1 Accessories

2.1.1 Optional respiratory humidifier

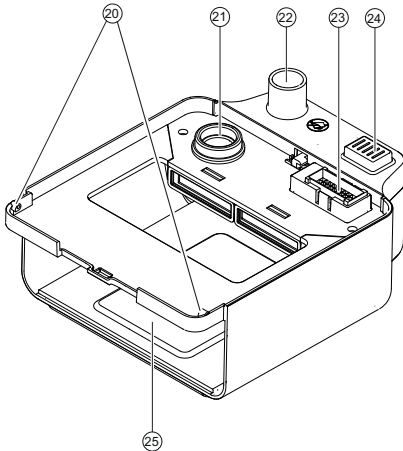

- 20. Holding fence
- 21. Air inlet of the respiratory humidifier
- 22. Air outlet
- 23. Connection socket for respiratory device
- 24. Release button
- 25. Heating plate

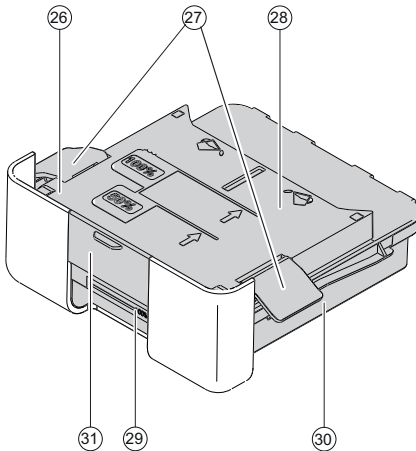

- 26. Cover for water chamber
- 27. Locking clamp
- 28. Heat transfer plate (bottom)
- 29. Level indicator to the water chamber
- 30. Water bowl to the water chamber
- 31. Unlocking handle to the water chamber

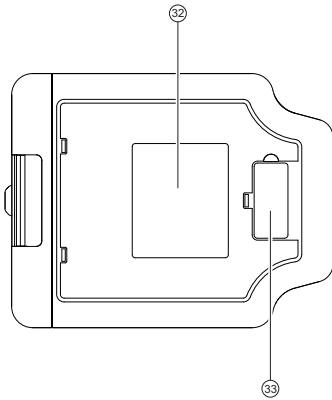

- 32. Type plate to the respiratory humidifier
- 33. Storage compartment for the silicone cover of the power connector (if respiratory humidifier is used)

2.1.2 Further accessories

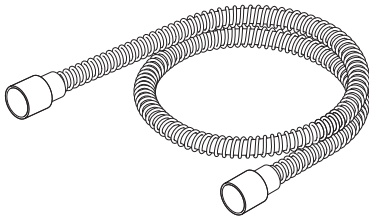

Tube system
in accordance with ISO 5367

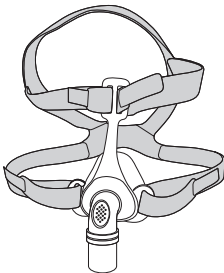

Respiratory mask
(diagram, not included in the scope
of supply)

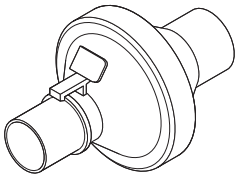

Bacterial filter
(diagram, not included in the scope
of supply)





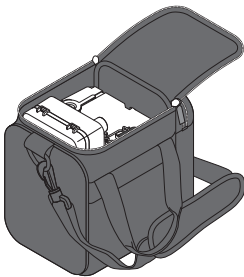





Mains cable (EU type)







Transport bag

2.2 Explanation of symbols



Symbols on type plate

Symbol	Meaning
	Manufacturer
	Date of manufacture
	Serial number
	Model number
	Alternating current
	Protection rating II
	Type BF application part
IP21	Protection from: IP21 + spillage Protection against the ingress of solid foreign bodies ≥ 12.5 mm diameter and larger, and against vertically falling water droplets plus spillage
	CE declaration of conformity
	The device cannot be disposed of in domestic waste. You can find information about the proper disposal of the device on Page 63.

Symbols on the device

Symbol	Meaning
	Follow user instructions
	Alternating current
	USB connections
	Loudspeaker

Symbols in the clinical manual

Symbol	Meaning
	WARNING This symbol designates an extraordinarily dangerous situation. Failure to follow this information can result in serious injuries and even death.
	CAUTION This symbol designates a dangerous situation. Failure to follow this information can result in slight or moderate injuries.

Note

This symbol designates information, indications and tips on how to handle the device without any problems.

3. PUTTING THE DEVICE INTO SERVICE

3.1 Setting up the device



Warning

Take care when setting up the device that the air inlet on the back of the device is not blocked by curtains, bedding etc.

- Ensure that the device is put into service by following the instructions below.
- Place the device a minimum distance of 5 cm from the wall.
- Place the device on a level, dust-free surface, such as a bedside table or on the floor next to the bed.
- Do not place the device on a soft surface, such as a bed or a couch.
- Place the device in such a way that the mains plug can be unplugged at any time without problems.
- Pay attention that the therapy tube cannot strangle the patient.

3.2 Connecting the device

The device can be used with or without respiratory humidifier.

Without respiratory humidifier

1. The openings to the air outlet and the connection socket for the respiratory humidifier can be found underneath the device. Check that the openings are sealed with the silicone covers provided.

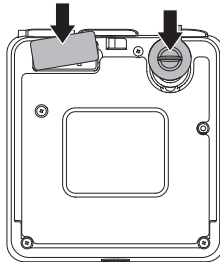

2. Connect the power mains cable to the device. Secure the power cable to

the device with the help of the safety clip. Insert the other end of the mains cable into a socket.

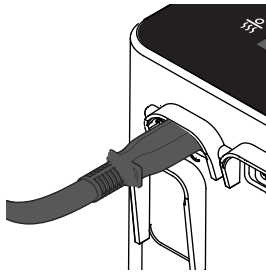

3. Connect the respiratory tube on the air outlet on the back of the device.

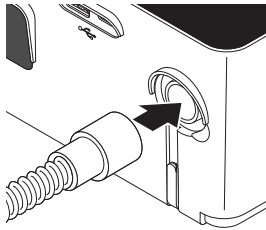

4. Connect the other end of the respiratory tube to the mask.

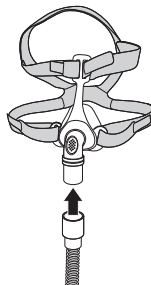

With respiratory humidifier

1. Check that the opening for the air outlet on the back of the device is closed with the silicone cover.

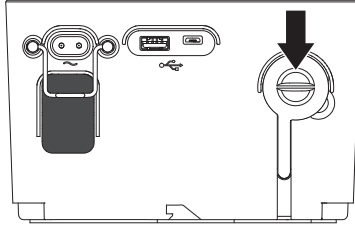

2. Ensure that the silicone cover for the respiratory humidifier's connection socket under the device has been removed.

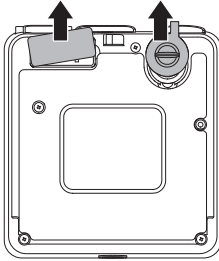

3. There is a storage recess for the silicone cover of the connection underneath the respiratory humidifier. Insert the silicone cover into this storage recess to avoid this getting lost by accident.

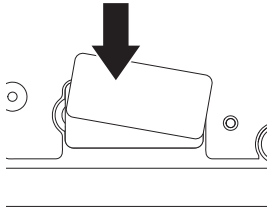

**Underside of
respiratory humidifier**

4. Connect the respiratory humidifier to the device. To do this, place the device on the respiratory humidifier so that it is connected on the front. Ensure that the holding fence of the respiratory humidifier hooks into the corresponding lugs of the device. Press the back of the device down.

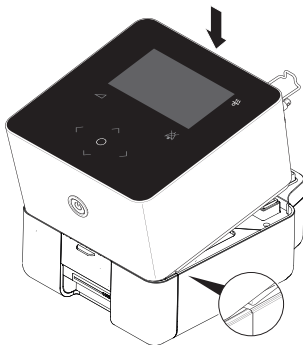

5. Connect the power mains cable to the device. Secure the power cable to the device with the help of the safety clip. Insert the other end of the mains cable into a socket.

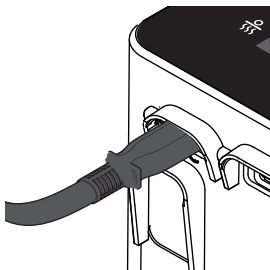

6. Connect the respiratory tube to the air outlet on the respiratory humidifier.

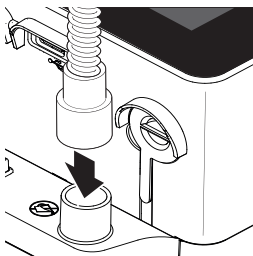

7. Connect the other end of the respiratory tube to the mask.

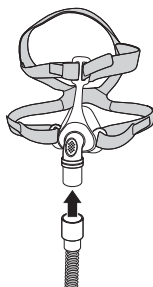

3.3 Fitting the respiratory mask

Note *The device requires a respiratory mask with integrated air outlet. Otherwise, CO₂ may be reinhaled.*

The device is suitable for use with nasal, oral-nasal, pillow and full-face masks. Please follow the relevant user instructions before fitting the respiratory mask.

3.4 Connecting bacterial filter



Warning

If the plan is to use the device with several patients (e.g. in a small clinic), it is necessary to provide the device with a bacterial filter to protect it from contamination with bacteria.

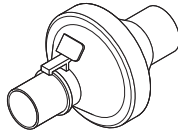

The bacterial filter is placed between the device's air outlet and the tube system. Please also note the manufacturer's user instruction.

Please only use bacteria filter which comply to ISO 23328-1/23328-2.

4. USING THE DEVICE DAILY

4.1 Starting therapy



Warning

Do not carry out therapy while the device is connected to the PC via the USB port.

- Put on the respiratory mask. For detailed information on the correct fit of the respiratory mask please refer to the manufacturer information.
- Press the start/stop button to start therapy.

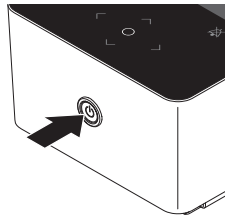

4.2 Setting the respiratory humidifier

Note *Always leave the device to cool for at least 10 minutes after the end of therapy before you remove the water chamber.*

- Check the water level in the water chamber of the respiratory humidifier.
- Pressing the right/left keys of the navigation buttons on the device allows the required heat level to be set on the standby screen of Patient mode.

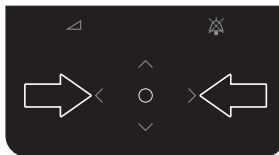

- The heat output of the respiratory humidifier can be selected in 6 levels

(off, 1-5, in 1 steps).

- The device saves the step set so that it may be started when it is next used.
- The heating plate can be switched off to use the device with a humidifier connected not using humidification.

4.3 Switching therapy sets

The device enables the user to choose one of two therapy sets. This might be useful in case the patient uses different mask configurations or if the patient uses different setups during day and night time.

Through Menu > Therapy settings > Dual set the current set can be changed.



The status bar shows which set is currently enabled.



The chosen therapy set is shown in the status bar or the screen which changes the color to purple in case the second set is chosen.

4.4 Handling alarms

The device has different alarms and error messages that can occur during the operation.

If the device is in an active state (i.e. it has been operated during the last two minutes) the alarms and the error messages are notified by an alarm status bar being illuminated in the display and an acoustic signal sounding.

The colour of the alarm status bar varies depending on the alarm's priority that has occurred (red for high priority, yellow for medium priority and turquoise for low priority).

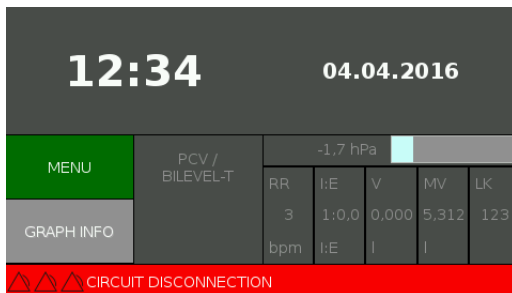

If the device is in the standby state (i.e. has not been operated for at least two minutes) an alarm list that completes the entire display appears and an acoustic signal sounds.

The alarm list shows the 5 highest prioritised alarms.

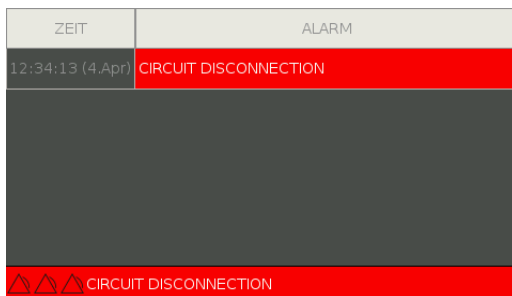

The device changes to the active state after you press any key. The alarms are then detailed in the status bar.

4.4.1 Pausing alarms

- You can switch the acoustic alarm to pause for the duration of two minutes by pressing the "Audio pause" key.

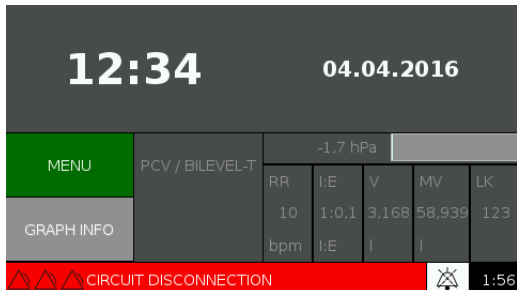
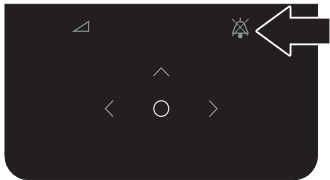

- After a period of two minutes the device reactivates the acoustic signal if the triggering event is still present.
- When you press the "Audio pause" key again during the activated 2-minute counter the duration is reset to two minutes, provided there is still a triggering event. The counter is deactivated if the triggering event has been rectified in the meantime.
- The "Audio pause" key may also be pressed as a matter of precaution if there is a foreseeable condition for an alarm, e.g. before secretion is taken from a patient. At this point the alarms are switched to pause for two minutes.

You can check a more accurate list of the alarms and error messages on Page 38.

4.5 Stopping therapy

- Remove the respiratory mask.
- Press the start/stop button for the period of 3 seconds. Therapy is stopped when you release the button.

The device signals that therapy has been switched off by a beep and by notification in the display.



- Pull the tube system out of the respiratory mask.
- Clean the respiratory mask and the tube system. Read a description about this on Page 49.

4.6 Switching off the device

The device can remain in standby mode.

However, should you wish to switch it off completely, pull the mains connector out of the socket.

4.7 Travelling with device

Remember to pack the following items:

- Device
- Power supply
- Tube system
- Respiratory mask (including exhalation system if required)
- Respiratory humidifier, if necessary
- Replacement filters and user instructions, if necessary

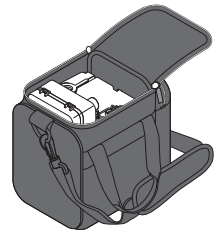

The **Cube 30 ATV** has a universal power supply that works with mains voltages between 100 and 240 V. It is therefore not necessary to make any changes relating to this on the device. You may need a travel plug adapter to be able to use the power cable in the destination country.

The **Cube 30 ATV** can be used on the plane if the plane is operated via a 100-240 V AC power source.

5. FUNCTIONAL DESCRIPTION

This chapter has only informative character. The therapy settings shall only be adjusted by a doctor and cannot be changed by the patient.

5.1 General function of the device

The device sucks ambient air through the filter system into the device where it is compressed by the blower unit. The compressed air is directed through the therapy tube to the mask of the patient.

The device uses sensors to capture pressure and flow information which are used to get mask pressure as well as breathing phases of the patient. The device uses this information to apply the prescribed therapy.

5.2 Therapy modes

The device has the following therapy modes with the help of which it can be adapted for each individual patient and their individual requirements.

Most of the therapies have two pressure levels (= Bilevel) and differentiate between inhalation and exhalation phase. A breathing cycle starts at the beginning of inspiration and lasts to the end of expiration. Breathing frequency are the number of breathing cycles within a minute.

The doctor can set the following therapy modes on the device: CPAP, PSV-S / Bilevel S, PCV / Bilevel T, PSV / Bilevel ST, APCV.

CPAP

Continuous Positive Airway Pressure.

In CPAP mode a constant pressure level is maintained over the entire respiratory cycle.

PSV-S / Bilevel S

Pressure Support Ventilation Spontaneous.

The patient is respirated with a bilevel mode, at which the pressure support is synchronised with the patient's breathing. When the patient inhales spontaneously the device activates the IPAP (Inspiratory Positive Airway Pressure) and

then returns, released by the patient exhaling into the EPAP (Expiratory Positive Airway Pressure). If the patient does not exhale for a set period (can be set by Ti max), the device switches to EPAP latest after the set period.

PCV / Bilevel T

Pressure Controlled Ventilation.

The patient is respirated with a bilevel mode, at which the pressure support is triggered by the device. The device gives a set, two-stage pressure support, without the patient's respiratory cycle affecting the frequency of the pressure values. The switch from IPAP to EPAP is based on the set inspiration time, the duration of the cycle on the set respiratory rate.

PSV / Bilevel ST

Pressure Support Ventilation.

The patient is respirated with a bilevel mode, at which the pressure support of the breaths is either triggered by the patient himself or the device. The mode is similar to the PSV-S / Bilevel S, only that the device runs at a set respiratory rate and therefore time-controlled respiratory cycles in the absence of any respiratory effort on the part of the patient.

APCV

Assisted Pressure Controlled Ventilation.

The therapy mode is similar to the PCV / Bilevel T, only that the respiratory cycles can also be triggered by the patient. The patient's spontaneous inhalation (trigger) triggers the IPAP and then the device starts the preset respiratory cycle. If no trigger can be found a timed cycle just like on PCV is given.

5.3 Additional therapy functions

The device also offers the following therapy functions.

5.3.1 Ramp

To make the start of therapy more pleasant for the patient, there is the option to set a ramp, through which the pressure level is slowly raised up to the therapy pressure.

The ramp pressure is set as a default by the doctor, the ramp time can be set by the patient.

5.3.2 Target volume

The device offers the option of setting the intended tidal volume that the patient is to reach during the breath. In case the tidal volume is lower the device will increase the support pressure.

5.3.3 Target minute volume

The device offers the option to set an intended air volume that the patient is to achieve over the period of a minute. In case the air volume is lower the device will increase the support pressure.

5.4 Alarms

The device is able to recognise the following fixed and modifiable alarms. Each alarm has a priority which is defined by the possible impact in case no one reacts to the alarm. An detailed description of the different priorities can be found on Page 38. The alarm settings will remain valid after power loss.

Display	Priority
Circuit disconnection	High
Mains failure	Moderate
Tube blocked	Moderate
System error	High
High pressure	Moderate

Display	Priority
Leakage	Low
Non vented mask	Moderate
Low minute volume	Moderate
High respiratory rate	Low
Low respiratory rate	Moderate
Target volume not reached	Moderate
Target minute volume not reached	Moderate

6. SETTING THE DEVICE

6.1 Control panel

The standby screen appears on the display when you switch on the device. The navigation buttons are underneath the display with the left, right, up and down keys. There is an OK button in the middle of the navigation buttons. Only the keys that currently have a function are lit.

6.1.1 Operating principles

You are able to navigate in the menu using the left, right, up and down keys. The OK key selects the corresponding menu option and confirms the entry.

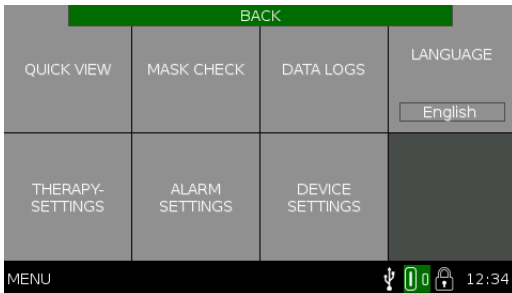

You get back to the previous menu level using the menu option back on the top edge.

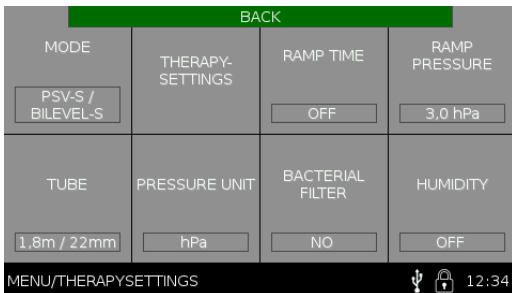

The status bar in the bottom edge shows the menu path you are currently in while you are navigating.

When setting up parameters you are able to change the parameter value by pressing the right/left keys and confirm the set value by pressing the OK key.

To cancel the setting operation and leave the submenu, press the up key until the Cancel field is selected and confirm Cancel with the OK key.

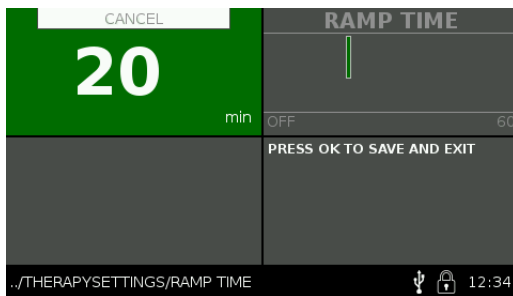

6.2 Standby screen



The standby screen shows the time and date in the top section. If the respiratory humidifier is connected, the set heating performance of the respiratory humidifier is displayed in this area. The heat level then works via the right/left keys.

The menu or a graph of the current therapy can be selected on the left-hand side. The mode currently selected can be found next to it.

With ongoing therapy the current status is displayed on the right-hand side by means of different measured values.

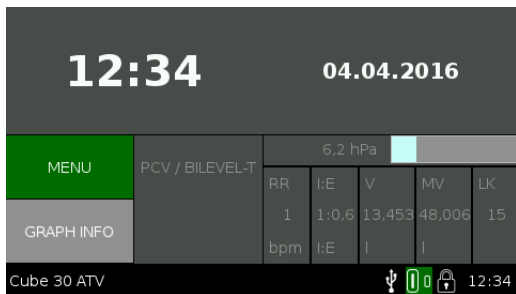

6.2.1 Therapy status range

Parameter	Description
RR	Respiratory Rate. The number of breaths per minute, averaged over the last five breaths.
I:E	I:E ratio. The ratio of inspiration to expiration. Calculated from the last breath.
Vi	Tidal volume. The tidal volume is the integral of the measured patient flow during inspiration.
MV	Breath minute volume. The breath minute volume is the volume of respiratory air that is inhaled and exhaled per minute. The breath minute volume is calculated from the last five tidal volumes with the corresponding breath frequencies.
LK	Leakage. The calculated flow that escapes through the leakage valve and possible leaks at the mask.
Pressure (hPa/cm H ₂ O)	The current mask pressure is displayed. This is calculated from the measured pressure and the pressure drop via the tube and if necessary respiratory humidifier.

6.2.2 Status bar

The time and the activity of the various device functions are read with the help of the icons in the right-hand area in the status bar next to the currently selected menu option. The icons are hidden if any of the functions is switched off.

Even information about the ramp, provided this has been enabled, can be found in the middle of the status bar.



Status bar in Normal mode



Status bar in Alarm mode



"Audio pause" key has been pressed and the counter of two minutes has been activated.



The alarm priority is indicated: one symbol for low priority, two symbols for moderate priority, three symbols for high priority.

12:34

Time



Connected USB device has been found.



The device is in Patient mode.



The device is in Clinical mode.



The device runs a ramp to reach target pressure. The remaining time is shown besides the icon.

6.2.3 Graph

If you select the "Graph info" option, a graphical representation of the last 30 seconds of the mask pressure and the patient flow appears on the display in real time.

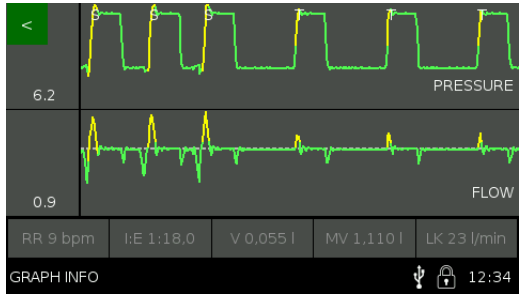

The current measured value is displayed on the left-hand side of each of the graphs.

The values of the therapy status area are displayed at the bottom (see Page 28).

In the Bilevel ST or APCV mode, the inspiration is indicated with S or T.(S) stands for spontaneous inspiration (T) stands for timed mode.

6.3 Menu

6.3.1 Quick view

The screenshot shows a menu screen with a green 'BACK' button at the top. Below it is a table with two columns: 'PARAMETER' and 'VALUE'. The table contains the following data:

PARAMETER	VALUE
DAILY THERAPY TIME	0 h/day
THERAPY HOURS	0 h
OPERATING TIME	412 h
SOFTWARE	1.2.0
FIRMWARE	1.1.27

At the bottom, it says 'MENU/QUICK VIEW' and shows a USB icon, a lock icon, and the time '12:34'.

You will find a list of the therapy time used per day, the total usage of the device, the total operating time and the current software/firmware version under Quick view.

6.3.2 Menu overview

The device is in Patient mode. The suboptions of the menu, where you are able to change settings yourself, are designated with an *. All further suboptions show the configurations set by the doctor.

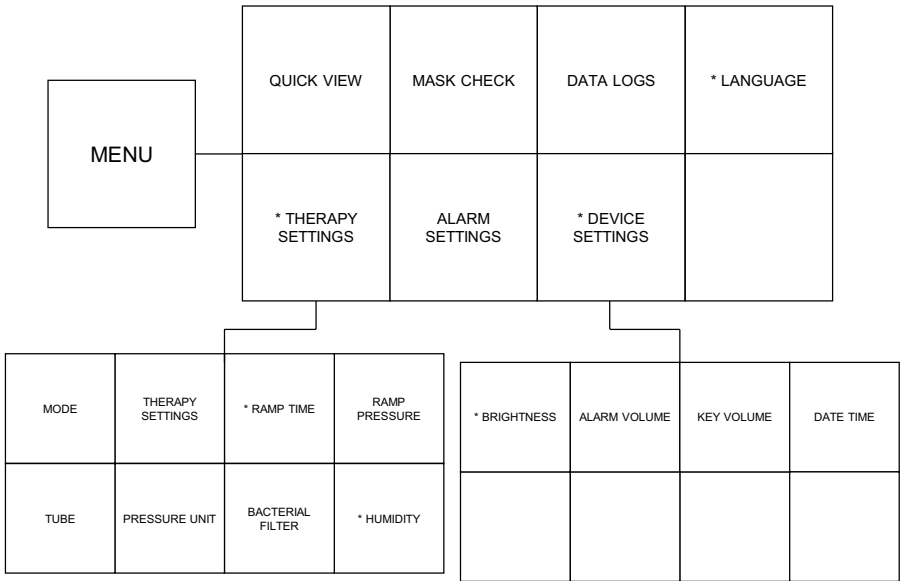

6.3.3 Device settings

The following parameters can be set for the device.

Parameter	Setting range/ Default	Description
Brightness Display active	Default: 100% Range: 40-100% Step: 10%	Sets the brightness of the display in normal mode.

Parameter	Setting range/ Default	Description
Brightness Display standby	Default: Off Range: Off, 10-100% Step: 10%	Sets the brightness of the display in standby mode.
Brightness Controls active	Default: 100% Range: 40-100% Step: 10%	Sets the brightness of the device keys in normal mode.
Brightness Controls standby	Default: Off Range: Off, 10-100% Step: 10%	Sets the brightness of the device keys in standby mode.
Brightness Humidifier standby	Default: 0% Range: 0-100% Step: 10%	Sets the brightness of the LED that displays if the respiratory humidifier is switched on.
Volume keys	Default: 30% Range: Off, 10-100% Step: 10%	Sets the volume of the keys.
Time	Default set by Service	Sets the time of the device.
Time format	Default: 24 hours Options: 24 hours, 12 hours	Sets the time format.
Date	Default set by Service	Sets the date for the device.
Date format	Default: DD.MM.YYYY Options: DD.MM.YYYY, MM/DD/YYYY	Set the date format.
Language	Default: German Options: The available languages are dependent upon the regional configurations.	Sets the device language.

6.4 Viewing the data logs

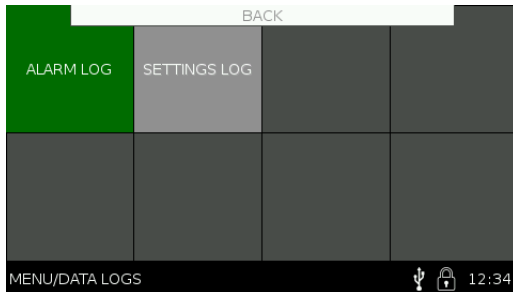

6.4.1 Alarm log

To obtain a display of all alarms that occur, you have to select the Alarm log menu option.

- Go to Menu > Data logs > Alarm log and press the OK key to confirm.
- The log appears on the display with the last alarms that occurred.

The following data Date, Time and Alarm type is displayed in the alarm log. The alarm log is sorted chronologically, i.e. the last alarm that occurred is at the top. It includes 50 alarms. After this the oldest alarm is overwritten each time.

The alarm log is retained even after the failure of the device's power supply.

6.4.2 Settings log

To get a display of the previous device settings, you have select the Settings log menu option.

- Go to the Menu > Data logs > Settings log and press the OK key to confirm.
- The log appears on the display with the last settings made.

The following data is displayed in the settings log: Date, Time, Parameters, old and new value.

The settings log is sorted chronologically, i.e. the last setting made is at the

top. It comprises 90 setting changes. After this the oldest setting change is overwritten each time.
The settings log is retained even after the failure of the device's power supply.

6.5 Data management



Warning

Do not carry out therapy while the device is connected to the PC via the USB port.

Note *Ensure that the data has been completely transferred before you remove the USB stick. Otherwise, loss of data and incorrect data may be the result.*

The **Cube 30 ATV** has two USB ports (1x USB-A, 1x Micro USB) on the back of the device. The therapy and device data can be saved via the USB A port with a USB stick. The device can be connected to a PC via the micro USB port.

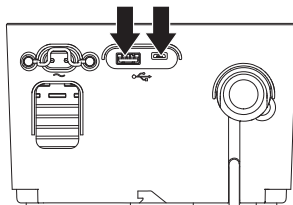

6.5.1 Backing up patient data

- Connect the USB stick to the USB A connection on the back of the device.
- The device checks the USB stick to see if there is sufficient storage space available to back up the patient data.
- If the USB stick is suitable, the device starts to back up the therapy data automatically.
- At the end of the data backup a corresponding message will be shown on the display and you can remove the USB stick again.

6.6 Function test

The device carries out an automatic function test each time it is connected to the power supply, during which important hardware components are checked. The device generates two acoustic signal beeps during the course of the function test that show that the acoustic alarm system is functioning. If errors are identified during the function test, these are shown in the display. Read the section on operational malfunctions for further information Page 38.

6.7 Testing the alarms

Manual testing of the alarms is not necessary because of the automatic function test of the device. If you still want to check the alarms, follow the instructions regarding alarm simulation.

Alarm simulation

To simulate the alarm, please set up the device as follows: with a 1.80 m / 22 mm tube, a nasal respiratory mask, without respiratory humidifier and without bacterial filter. Check that the settings have been made accordingly under therapy settings.

Alarm	Simulation
Circuit disconnection	<ul style="list-style-type: none">• Start the therapy.• Pull the tube out of the device. The alarm should sound within 10 seconds.
Mains failure	<ul style="list-style-type: none">• Start the therapy.• Pull the power cable out of the socket. The alarm should sound directly.
Tube blocked	<ul style="list-style-type: none">• Start the therapy.• Hold the tube with your hand so that no further leakage is possible. The alarm should sound within 20 seconds.
System error	This alarm sounds if the device component is defective. It therefore cannot be tested without damaging the device.

Alarm	Simulation
High pressure	<ul style="list-style-type: none"> • Start the therapy. • Block the air inlet. • Introduce strong pressure into the device via the air outlet (although not more than 50 hPa; otherwise the device could be damaged). <p>The alarm should sound within 10 seconds.</p>
Leakage	<ul style="list-style-type: none"> • Ensure that the alarm is activated. • Start the therapy. • Release the respiratory mask partly from your face so that there is no further significant leakage. <p>The alarm should sound within 10 seconds.</p>
Non vented mask	<ul style="list-style-type: none"> • Ensure that the alarm is activated. • Set the PCV / Bilevel T mode. • Connect an artificial lung without a leak system. • Start the therapy. <p>The alarm should sound within 10 seconds.</p>
Low minute volume	<ul style="list-style-type: none"> • Ensure that the alarm is activated. • Set the PCV / Bilevel T mode. • Connect an artificial lung with a cubic capacity of 500 ml and leak system. • Set the therapy parameters to the following values: <ul style="list-style-type: none"> - Respiratory rate to 8 bpm - IPAP to 15 hPa/cm H₂O - EPAP to 5 hPa/cm H₂O - "Low minute volume" alarm to 6 l • Start the therapy. <p>The alarm should sound within 60 seconds.</p>
High respiratory rate	<ul style="list-style-type: none"> • Ensure that the alarm is activated. • Set the PCV / Bilevel T mode. • Connect an artificial lung with a cubic capacity of 500 ml. • Set the therapy parameters to the following values: <ul style="list-style-type: none"> - Respiratory rate to 30 bpm - IPAP to 15 hPa/cm H₂O - EPAP to 5 hPa/cm H₂O - "High respiratory rate" to 20 bpm • Start the therapy. <p>The alarm should sound within 5 seconds.</p>

Alarm	Simulation
Low respiratory rate	<ul style="list-style-type: none"> • Ensure that the alarm is activated. • Set the PCV / Bilevel T mode. • Connect an artificial lung with a cubic capacity of 500 ml. • Set the therapy parameters to the following values: <ul style="list-style-type: none"> - Respiratory rate to 10 bpm - "Low respiratory rate" alarm to 15 bpm • Start the therapy. <p>The alarm should sound within 5 seconds.</p>
Target volume not reached	<ul style="list-style-type: none"> • Set the "Target volume not reached" alarm and all other modifiable alarms. • Set the PCV / Bilevel T mode. • Set the therapy parameters to the following values: <ul style="list-style-type: none"> - IPAP to 8 hPa - EPAP to 6 hPa - Backup rate to 8 bpm - Target volume (parameter) to 1.000 l - Pressure support to 0.5 hPa - Maximum pressure increase per breath to 0.5 hPa • Connect an artificial lung with too low a respiratory volume. <p>The alarm should sound when the set value is not reached despite the maximum pressure increase for 15 seconds.</p>
Target minute volume not reached	<ul style="list-style-type: none"> • Set the alarm "Target minute volume not reached" and switch all other alarms that can be modified off. • Set the PCV / Bilevel T mode. • Set the therapy parameters to the following values: <ul style="list-style-type: none"> - IPAP to 8 hPa - EPAP to 6 hPa - Backup rate to 8 bpm - Target minute volume (parameter) to 1.000 l - Pressure support to 0.5 hPa - Maximum pressure increase per breath to 0.5 hPa • Connect an artificial lung with too low a respiratory volume. <p>The alarm should sound if the set value is not reached despite the maximum pressure increase for 1 minute.</p>

7. OPERATING MALFUNCTIONS

7.1 Alarms

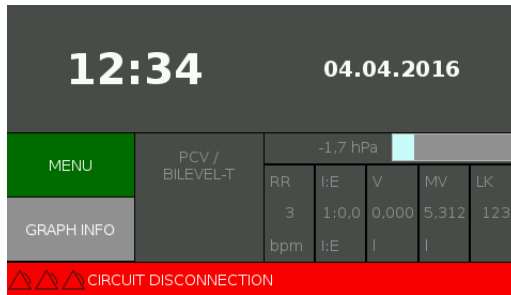

The device issues alarms of different priority. These differ in terms of a possible result if the cause of the alarm is not responded to.

High priority

The result of a high-priority alarm can be the death or irreversible injury to the patient. This is shown in the device display by three red . An acoustic signal also sounds (see following table).

Moderate priority

The result of a moderate-priority alarm can be reversible injury to the patient. It is shown in the device display by two yellow . An acoustic signal also sounds (see following table).



Low priority



The result of a low-priority alarm can be minor, reversible injuries to the patient or slight damage to the device. It is shown in the device display by a turquoise . An acoustic signal also sounds (see following table).





Acoustic signals

In addition to the visual signals in the device display the device also issues an

acoustic signal. This consists of a sequence of tones that vary depending on the nature of the alarm and priority. The sequence of tones is indicated in the following table by the letters forming each tone pitch (c, a, f, e). The C is an octave above c.

Display	Priority (Display)	Acoustic	Cause	Length of trigger	Measure
Circuit disconnection	High 	c a f - a f	The device detects a fall in pressure in the exhalation system. The tube system has probably become detached.	10 sec	Checks the tube system's connections.
Mains failure	Moderate 	Beep (for 2 minutes)	The device no longer has power supply.	Direct	Check the power supply connection.
Tube blocked	Moderate 	c a f	The device detects an obstruction in the tube system.	10 sec	Check the tube system for any potential blockages. Remove any potential blockages. Restart the therapy.

Display	Priority (Display)	Acoustic	Cause	Length of trigger	Measure
System error	Moderate 	C c c	There is an internal error.	Direct	Remove connector, wait 5 minutes and restart device. <i>Note: The backup alarm will be discharged during the 5 minute wait.</i> If there is still an error, please contact Service.
	No further display possible	3 second tone (4 kHz), 3 second pause	The hardware for the device has failed.	Direct	Please disconnect the connector to end the acoustic signal. Please contact Service.
High pressure	Moderate 	c a f	The therapy pressure exceeds the set limit value.	10 sec	Stop the therapy. This alarm cannot occur unless the patient has breathed strongly against the device. Please contact Service department if the alarm still occurs.
Leakage	Low 	e c	The device detects a high system flow (leakage). The respiratory mask has possibly slipped.	10 sec	Check the fit of the respiratory mask.

Display	Priority (Display)	Acoustic	Cause	Length of trigger	Measure
Non vented mask	Moderate 	c a f	A respiratory mask is being used without an air outlet, or the air outlet is blocked.	10 sec	Ensure that the patient is using a respiratory mask with an air outlet. Check that the air outlet openings are not blocked.
Low minute volume	Moderate 	c a f	The respiratory minute volume is lower than the set limit value.	10 sec	The patient's condition should be checked.
High respiratory rate	Low 	e c	The respiratory rate exceeds the set limit value.	5 sec	The patient's condition should be checked.
Low respiratory rate	Moderate 	c a f	The respiratory rate is below the set limit value.	5 sec	The patient's condition should be checked.
Target volume not reached	Moderate 	c a f	The target volume is not reached despite the maximum indicated inspiration pressure.	Immediately, if not reached despite the maximum additional pressure	The patient's condition should be checked.

Display	Priority (Display)	Acoustic	Cause	Length of trigger	Measure
Target minute volume not reached	Moderate 	c a f	The target minute volume is not reached despite the maximum indicated inspiration pressure.	Immediately, if not reached despite the maximum additional pressure	The patient's condition should be checked.

Informative signals

In addition to the alarms there are informative signals. The following signals are for information purposes only:

Reason of the signal	Frequency and interval
System start	261 Hz (for 80 ms) - 80 ms pause - 523 Hz (for 80 ms)
Button strike	220 Hz (for 20 ms)
Therapy stop	880 Hz (for 250 ms) - 100 ms pause - 1760 Hz (for 100 ms)
Accepted	880 Hz (for 750 ms)
Abort	880 Hz (for 150 ms) - 150 ms pause - 880 Hz (for 150 ms) - 150 ms pause 880 Hz (for 150 ms)

7.2 Handling errors

7.2.1 Error messages (display)

Error message	Possible cause	Measure
"Internal storage error. Settings reset. Code E1"	Software error.	Do not start the therapy. Contact your doctor or your medical advisor to have the settings checked. If the error message appears again, please contact your service partner.
"Internal storage error. Settings reset. Code E2"	Software error.	Do not start the therapy. Contact your doctor or your medical advisor to have the settings checked. If the error message appears again, please contact your service partner.
"Clock not set."	The time on the device is not set.	Please set the time in the menu. If the error message appears several times the clock battery will soon be depleted. Please contact your service partner.
"Clock not calibrated."	The clock on the device has not been calibrated.	Please contact your service partner.
"Clock battery depleted."	The clock battery is depleted.	Please contact your service partner.
"Check humidifier."	The respiratory humidifier has a fault.	Please check the installation of the respiratory humidifier. If everything is installed correctly, contact your service partner.

7.2.2 Troubleshooting

Problem	Possible cause	Measure
Nothing being shown on the display. No running noise.	Device is in standby mode and brightness of the display in standby mode is set to "off".	Press a key on the device. The device should wake up from standby mode. If this does not happen, please investigate other possible causes.
	No power to the device.	Check that the power cable is fitted correctly to the device and to the socket. Ensure there is no general power outage.
Device is running but does not reach the set therapy pressure (CPAP/IPAP).	Filter is dirty.	Check the filters and clean/change them, if necessary.
	Air outlet is blocked, for example.	Ensure the air inlet to the device is freely accessible.
	There is a leakage in the respiratory mask or tube system.	Check the respiratory mask and tube system are fitted correctly and for potential faults. Replace any relevant components, if necessary.
Air current does not switch on.	Device is in standby mode.	Press the start/stop button to ensure that the device is not in standby mode.
	Tube blocked.	Check condition of the tube system and that there are no blockages.
	Device defective.	Switch the device off and on again. If the problem continues, contact your service partner.

Problem	Possible cause	Measure
Air stream is warmer than usual.	Device is close to the heating/ in sunlight.	Ensure that the device is placed away from sunlight and heating.
	Fluctuations in temperature of the air stream depending on room temperature.	Ensure that the air inlet to the device is not blocked by curtains or bedding. Reduce the room temperature if necessary.
	Respiratory humidifier is connected; water chamber has not been filled up.	Check the settings and the water chamber of the respiratory humidifier. Make any changes to the settings and fill the water chamber of the air humidifier, if necessary.
Dry nasal mucous membrane	Device is being operated without respiratory humidifier	Install a respiratory humidifier to reduce possible symptoms, such as dry nasal mucous membrane, dried out mouth or sore throat by moistening the inhaled air.
	Device being operated with respiratory humidifier and at too low a heat level	Gradually increase the heat level of the respiratory humidifier to increase the air humidity of the respiratory air.

Problem	Possible cause	Measure
Air stream is not warmed/not humidified when the air humidifier is connected.	Respiratory humidifier is not connected correctly.	Check that the respiratory humidifier's LED is illuminated on the device. The respiratory humidifier is connected correctly if the LED is illuminated. If not, detach the device from the respiratory humidifier and reconnect them again.
	Heat level set incorrectly.	Check the set heat level of the respiratory humidifier on the display. Increase the set value if necessary. <i>Note: After switching on the respiratory humidifier it has a preheating time of approximately 30 minutes to heat the water in the water chamber.</i>
	Water chamber is empty.	Check that the water chamber for the respiratory humidifier has been filled and fill it with more water, if necessary.
	Respiratory humidifier is defective.	If none of the other possible causes apply, contact your service partner.
Language distorted	Accidental distortion of the device's language, so that the user can no longer operate the device	The menu option for setting the device language can be found in the first menu window (see Page 29).

8. CLEANING AND MAINTAINING THE DEVICE



Caution

Service and maintenance must not be performed during operation of the device!

8.1 Intervals

The device and the individual components must be cleaned and maintained at regular intervals. You will find a user guide on how to clean the components from Page 48 onwards.

Components	Interval	Activity
Breathing device Cube 30 ATV	When needed	Clean device with damp cloth
Mains cable	When needed	Clean power cable with damp cloth
Respiratory mask	Daily	Clean respiratory mask
	Weekly	Clean respiratory mask thoroughly in accordance with the user instruction
Tube system	Daily	Clean tube system
	Annually	Change tube system
Coarse filter	Weekly	Clean coarse filter
	At the latest after 1500 operating hours	Replace coarse filter, earlier in the case of damage
Fine filter	Every 1000 operating hours	Replace fine filter (do not wash!)
	In the case of contamination	Replace fine filter (do not wash!)
Bacterial filter	In accordance with manufacturer's information	Replace bacterial filter

Components	Interval	Activity
Water chamber of the respiratory humidifier	Daily	Clean water chamber of the respiratory humidifier
Transport bag	When needed	Clean transport bag

8.2 Cleaning



Warning

After cleaning, ensure that all the device's elements and accessories are rinsed carefully with clean water. Any remaining residues of cleaning agents or descaling agents may harm the patient during therapy.



Caution

Do not clean the device and the housing of the respiratory humidifier in the dishwasher. This can result in material damage.

Note *Only use mild soapy water to clean the components. Do not use any bleach, chlorine, solutions containing alcohol or alkalis, or moisturising or antimicrobial soaps. These agents can harden the materials and therefore significantly shorten the service life.*

The following cleaning steps can be executed as often as required.

Housing

Note *Never submerge the housing in water or rinse off. Protect the openings and filters from ingress of liquids to prevent damage to the device. If, however, liquid should get into the device, please do not continue to use but contact the service department.*

- Disconnect device from the power supply.
- Wipe the device with a damp cloth to remove any dust.
- Allow the housing to dry completely before you use the device again.

Respiratory mask

Note Please observe the manufacturer's information.

- Disconnect the respiratory mask from the tube system.
- Clean the respiratory mask with mild soapy water.
- Then rinse the respiratory mask carefully with clean water.
- Allow the respiratory mask to air dry.

Tube system

Note Please observe the manufacturer's information.

- Disconnect the tube system from the device and respiratory mask.
- Wash the tube system with mild soapy water.
- Carefully rinse out the tube system with clean water.
- Allow the tube system to air dry.

Coarse filter

- Remove the dark coarse filter on the back of the device.

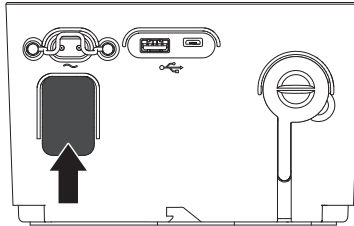

- Wash the coarse filter with mild soapy water.
- Rinse the coarse filter with clean water.
- Allow the coarse filter to dry completely before you use it again.

Water chamber of the respiratory humidifier

- Disconnect device from the power supply.
- Pull the water chamber out of the respiratory dehumidifier with the help of the unlocking handle.
- Press the opening lever on the water chamber to separate both halves of

the water chamber.

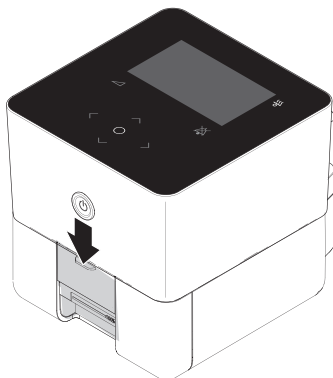

- Remove the gasket from the lower half of the water chamber.

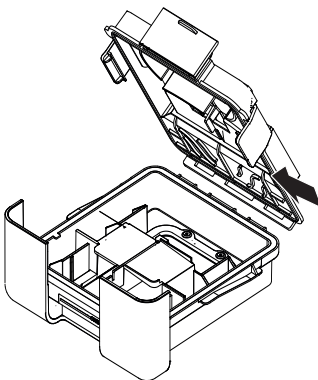

- Clean all parts of the water chamber with mild soapy water.
- Rinse all parts of the water chamber with clean water.
- Allow the individual parts to dry completely before you put them together again.

8.3 Maintenance

Replacing the coarse filter

- Remove the dark coarse filter on the back of the device.
- Dispose of the old coarse filter in normal domestic waste.
- Replace the coarse filter.

Replacing the fine filter

- First remove the dark coarse filter on the back of the device.
- Remove the clear fine filter that is located immediately behind the coarse filter.

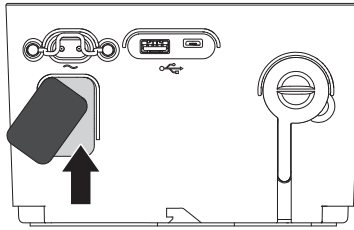

- Dispose of the old fine filter in normal domestic waste.
- Replace the fine filter.
- Place the coarse filter in front the fine filter again.

Replace bacterial filter

Note Please observe the manufacturer's information.

- Detach the bacterial filter from the tube system and device.
- Replace the bacterial filter and connect to the tube system and device again.

Safety checks

The device must be subject to a safety check at the prescribed intervals to ensure operating safety.

To maintain the device, the device must be serviced by an authorised distributor at the following interval as a preventative measure:

- After 20.000 operating hours (shown on the display).

8.4 Disinfection

If necessary, e.g. in the case of severely infectious diseases, you may disinfect the following device components:

- Housing
- Mains cable.

Please only use permitted disinfection agents. You will find more detailed information in the hygiene concept that can be obtained from your service partner.

Housing

Disinfect the housing and the air outlet, in particular, using a wipe-down disinfectant.

8.5 Disposing of

Device

The device may not be disposed of in normal domestic waste.

Please contact your authorised collection point or an authorised municipal authority waste disposal company for correct disposal. You can obtain the addresses from your municipal authority. Or send the device back to your service partner.

Packaging

You can dispose of your device's packaging in normal domestic waste.

Accessories and wear parts

You may dispose of the filters in normal domestic waste.

Please dispose of the tube and mask in accordance with the manufacturer's instructions.

9. SCOPE OF DELIVERY

9.1 Standard scope of delivery Cube 30 ATV

Part	Order number
Cube 30 ATV Device DE	P001G001
Cube 30 ATV Device UK	P001G002
Hose system (Ø 15 mm, length 1.80 m)	P001Z001
EU power cable	P001Z005
UK power cable	P001Z006
Fine filter	P001Z007
Coarse filter	P001Z008
Transport bag	P001Z009
User instruction	P001Z010

9.2 Accessories/spare parts

Part	Order number
Tube system, Ø 22 mm, length 1.80 m	P001Z002
Tube system, Ø 22 mm, length 2.70 m	P001Z003
Tube system, Ø 22 mm, length 3.60 m	P001Z004
Respiratory humidifier	P005
Water chamber	P005E001
Sealing gasket	P005E002
Silicone cover for air outlet	P001E001
Plug lock	P001E012

10. TECHNICAL DATA

10.1 Technical data

Device specification:

Sizes, W x H x D:	168 x 108 x 182 mm
weight:	1650 g
air outlet:	22 mm cone (in accordance with DIN EN ISO 5356-1)

Service areas:

Power supply:	100 - 240 V, 50/60 Hz
Max. power consumption:	1 A

Operating conditions:

Temperature range:	+5 °C to +40 °C
Relative air humidity range:	10% to 95% (excluding condensation)
Air pressure range:	600 hPa to 1100 hPa

Note: The power of the device can be restricted to below 800 hPa.

Transport/storage conditions:

Temperature range:	-20 °C to + 50 °C
Relative air humidity range:	10% - 95% (excluding condensation)
Air pressure range:	600 hPa to 1100 hPa

Tube system:	Flexible plastic
	For 22 mm diameter: 1.80 m/ 2.70 m/ 3.60 m length
	For 15 mm diameter: 1.80 m length

Sound pressure ranges:

Sound pressure level in accordance with DIN EN ISO 17510-1:2009:	< 32 dB
Sound power level in accordance with DIN EN ISO 17510-1:2009:	< 40 dB
Sound pressure level of alarm:	> 62 dB
Sound power level of alarm:	> 70 dB

Performance features:

Max. working pressure:	30 hPa (by pressure measurement/ adjustment)
Min. working pressure:	3 hPa (by pressure measurement/ adjustment)
Max. stable limit pressure:	40 hPa
Min. stable limit pressure:	0 hPa

Maximum respiratory resistance in the event of single failure:

Inspirational pressure on the patient connection opening of the device for a flow of 60 l/min:	4.05 hPa
Expiration pressure on the device's patient connection opening for a flow of 60 l/min:	4.18 hPa

Inspiration trigger:	Flow-based inspiration trigger Accuracy: $\pm 20\%$
----------------------	--

Expiration trigger:	The expiration trigger is triggered during the following percentages of the maximum flow during inspiration: 30 - 70% of the IPAP value Accuracy: $\pm 20\%$
---------------------	--

Pressure measurement:	Integrated pressure converter in the respiratory device Accuracy: ± 0.4 hPa
-----------------------	--

Short-term pressure stability in accordance with DIN EN ISO 17510-1:2009:	at 3 hPa: ± 0.5 hPa at 10 hPa: ± 0.5 hPa at 17 hPa: ± 0.5 hPa at 23 hPa: ± 1 hPa at 30 hPa: ± 1 hPa
---	---

Long-term pressure stability in accordance with DIN EN ISO 17510-1:2009:	< 0.1 hPa
--	-------------

Flow at maximum speed:	at 3 hPa: 193.5 l/min at 10 hPa: 184.5 l/min at 17 hPa: 164 l/min at 23 hPa: 147.7 l/min at 30 hPa: 125.7 l/min
Max. operating time/day:	16 hours/day
EMC in accordance with EN 60601-1-2/07.2007:	CISPR 11, class B
Product category in accordance with Directive 93/42/EEC:	II a
Classification to IEC 60601-1:2013 against electric shock:	BF type class II
IP protection class:	IP 21 Protection from: IP21 + spillage Protection against the ingress of solid foreign bodies ≥ 12.5 mm diameter and larger, and against vertically falling water droplets plus spillage
Expected operating life of the device:	5 years

All flow and volume values are given in STPD.

10.2 Display values therapy status range

Parameter	Range (step)	Accuracy	Refresh rate
RR	Range: 0-255 bpm Step: 1 bpm	± 1 bpm	Each breath
I:E	Range: 1:0.0 to 1:9.9 Step: 0.01	± 0.01	Each breath
Vi	Range: 0.0-65.535 l Step: 0.001 l	± 150 ml	Start of expiration
MV	Range: 0-65.535 l Step: 0.1 l	± 150 ml (+ mean value formation)	Start of expiration
LK	Range: 0-250 l/min Step: 1 l/min	± 3 l/min (+ mean value formation)	Marginal condition, dependent upon the leakage and leakage change
Pressure (hPa/cm H ₂ O)	Range: -5-40 hPa/cm H ₂ O Step: 0.1 hPa/cm H ₂ O	IPAP: ± 0.4 hPa EPAP: ± 0.4 hPa CPAP: ± 0.4 hPa	2 ms (+ mean average formation)
Flow	Range: -247-247 l/min Step: 1 l/min	± 1.1 l/min or $\pm 20\%$	5 ms

10.3 Setting ranges and accuracy of the therapy settings

Parameter	Setting range	Accuracy
CPAP	Range: 3-20 hPa/cm H ₂ O Step: 0.5 hPa/cm H ₂ O	± 0.4 hPa
IPAP	Range: 5-30 hPa/cm H ₂ O Step: 0.5 hPa/cm H ₂ O Dependency: ≥ EPAP + 2 hPa/cm H ₂ O	± 0.4 hPa
EPAP	Range: 3-25 hPa/cm H ₂ O Step: 0.5 hPa/cm H ₂ O Dependency: ≤ IPAP - 2 hPa/cm H ₂ O	± 0.4 hPa
Target volume	Range: Off, 0.100-2.000 l Step: 0.010 l	± 0.2 Pa
Target minute volume	Range: Off, 2.000-15.000 l Step: 0.100 l	± 0.2 Pa
Pressure support	Range: 0-25 hPa cm H ₂ O Step: 0.5 hPa/cm H ₂ O Dependency: ≤ 30 - IPAP	± 0.4 hPa
Maximum pressure increase per breath	Range: 0.1-2 hPa/cm H ₂ O Step: 0.1 hPa/cm H ₂ O	± 0.4 hPa
Inspiration slope	Range: Step 1-6 Step: 1	± 0.4 hPa
Expiration slope	Range: Step 1-6 Step: 1	± 0.4 hPa
Inspiration trigger	Range: Step 1-5 Step: 1	± 0.2 Pa
Expiration trigger	Range: Auto, 30-70% Step: 10%	± 0.2 Pa
Trigger lock	Range: 0.3-8.0 s Step: 0.1 s Dependency: ≤ (60:respiratory rate)- inspiration time	± 1 ms

Parameter	Setting range	Accuracy
Backup rate	Range: 4-40 bpm Step: 1 bpm	± 1 bpm
Inspiration time	Range: 0.4-5 s Step: 0.1 s Dependency: 20-80% of a respiratory cycle	± 1 ms
Ti min	Range: 0.3-5 s Step: 0.1 s Dependency: < Max. inspiration time	± 1 ms
Ti max	Range: 0.3-5 s Step: 0.1 s Dependency: > Min. inspiration time	± 1 ms
Ramp pressure	Range: 3-20 hPa/cm H ₂ O, step: 0.5 hPa/cm H ₂ O Dependency: ≤ CPAP, ≤ EPAP	± 0.4 hPa
Ramp time	Range: 0-60 min Step: 5 min	± 1 ms

10.4 Setting ranges and accuracy of the alarm parameters

Alarm	Setting range	Accuracy
High respiratory rate	Range: Off, 10-60 bpm Step: 1 bpm	± 1 bpm
Low respiratory rate	Rate: Off, 4-20 bpm Step: 1 bpm	± 1 bpm
Low minute volume	Range: Off, 2.000-15.000 l Step: 0.100 l	± 0.2 Pa
Leakage	Range: On, off	Not necessary
Non vented mask	Range: On, off	Not necessary
Target volume not reached	Range: On, off	± 0.2 Pa
Target minute volume not reached	Range: On, off	± 0.2 Pa

10.5 Pneumatic circuit diagram

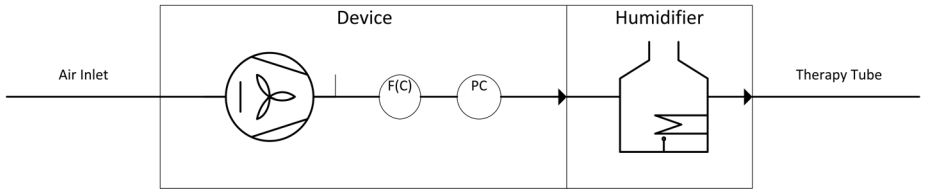

F(C): Flow meter with regulator characteristics if target volume or target minute volume are set.

PC: Pressure measurement with regulator characteristics.

10.6 Protective Distance

Please ensure the protective distances between the device and wireless communication devices such as mobile phones. Otherwise the therapy of the device might be influenced.

Maximum nominal power of sending source in W	Protective distance depending on frequency in m		
	150 kHz to 80 MHz	80 MHz to 800 MHz	800 MHz to 2,5 GHz
0.01	0.12	0.12	0.23
0.1	0.37	0.37	0.74
1	1.17	1.17	2.33
10	3.70	3.70	7.37
100	11.70	11.70	23.30

11. SAFETY INFORMATION/WARNINGS

11.1 Operating the device

WARNING

- If there is any damage to the housing do not put your hand or any metallic objects in the housing.
There is a risk of electric shock.
Contact your service partner if there are any obvious defect to the housing.
- The power cable may no longer be used if it is damaged in any way.
There is a risk of electric shock.
Contact your service partner to obtain a new power cable.
- The device may not be used by patients with a body weight of less than 13 kg. It has not been tested and approved for this type of application.
There is a risk of incorrect therapy settings.
Therefore use an appropriate special device.
- Avoid the device being exposed to high temperatures (above 80°C).
There is a risk of damage to the device and beyond this injury to the patient during therapy.
- Ensure that there is someone close at all times during therapy who is able to operate the device and react to alarms.
Otherwise, alarms may be ignored.
- Do not carry out therapy while the device is connected to the PC via the USB port.
The USB connection is not suitable for remote maintenance of the device.
- Pay attention that the therapy tube cannot strangulate the patient.
- Please ensure the protective distances between the device and wireless communication devices such as mobile phones. Otherwise the therapy of the device might be influenced. Further information on Page 62.
- Different alarm settings on the same or similar device within hospital wards might result in endangered patients.

Caution

- Set up the device in such a way that the air outlet cannot be blocked on the back of the device by curtains, bedding etc.
This could result in the device overheating and being damaged.

General information

- Please do not use anti-static or electric conducting tubes.
- Only use accessories described within the manual. If you are unsure about using accessories please contact your service provider.
- Attaching additional accessories to the device's patient interface might result in pressure increase at mask interface during expiration.
- During operation there should always be an alternative ventilation source.

11.2 Transport/maintenance

WARNING

- The prescribed service intervals (see Page 57 and Page 62) must be observed to guarantee the device runs smoothly.
Otherwise the quality of the therapy may suffer.
- The device must be hygienically prepared by the manufacturer or the service partner in the event of a change of patient if no bacterial filter was used previously.
Otherwise, there is a risk of infection for the new patient.
- After cleaning, ensure that all corresponding parts of the device have been carefully rinsed with clean water.
Any remaining residues of cleaning agents or descaling agents may harm the patient during therapy.
- Any modification of the device is not allowed.

Caution

- Do not clean the device and the housing of the respiratory humidifier in the dishwasher.
This can result in material damage.

Please observe the following cleaning information Page 58.

- Do not transport the device with the respiratory humidifier connected. Ensure that the water chamber of the respiratory humidifier has been emptied prior to being transported. Any ingress of water into the device may result in damage.
- The heating plate of the respiratory humidifier and the heat transfer plate on the underside of the water chamber may reach temperatures up to 74°C during the operation.

There is a risk of burns.

Leave the device to cool following therapy before you remove the water chamber.

12. INDEX

A		G	
Alarm		Graph	30
Display	18	K	
Handling	17	Keys	4
Log	33	L	
Mute	19	Language	32
Overview	24	M	
Priority	38	Menu	30
Rectify	38	Graph Info	30
APCV		Operation	26
Mode	23	Overview	31
B		Quick view	30
Bacterial filter		P	
Connect	15	PCV / Bilevel T	
Brightness	31	Mode	23
C		Plane	
CPAP mode	22	Use in the	21
D		PSV / Bilevel ST	
Date	32	Mode	23
Device		PSV-S / Bilevel S	
Set device parameters ...	31	Mode	22
Switch off	20	Q	
Display		Quick view	30
Brightness	31	R	
Brightness standby	32	Ramp	24
Dual Set		Respiratory humidifier	
Switch therapy sets	17	Connect	12
F			
Function test	35		

Set	16
S	
Settings	
Device	31
Log	33
Setup	
Bacterial filter	15
Device	10
Respiratory humidifier ...	12
Standby screen	27
Starting therapy	16
Stopping therapy	20
T	
Target minute volume	24
Target volume	24
Therapy	
Modes	22
Start	16
Status range	28
Stop	20
Time	32
Travelling with device	20
U	
USB stick	34
V	
Volume	
Keys	32



JFR Medical Instruments GmbH

Ostuferhafen 15, 24149 Kiel, Germany

T: 0431 - 7298 740-0, F: 0431 - 7298 740-19

E: info@jfr-gmbh.de

Customer Service:

Version 03/2018 - User Manual, Cube 30 ATV, English
Software Version: 2.X.X